

2020 / 2021



Fischer Panda Marine Generators





compact



light



quiet

“Power - wherever you are” with Fischer Panda

You will always have sufficient power with a Fischer Panda generator

- Generator systems from 3 kW to 200 kW
- Worldwide partners near you
- Very low vibration and quiet installation
- Up to 40 % weight and 60 % space savings possible
- Parallel operation with multiple generators
- Integration with yacht's main control systems

Fischer Panda GmbH manufactures compact and quiet diesel generators for marine and vehicle applications. These are sold in over 80 countries worldwide under the trade name “Fischer Panda”.

The water-cooled diesel generators from Fischer Panda are renowned worldwide for being innovative, reliable and extremely quiet. The product range includes over two hundred different generators for performance ranges up to 200 kW.

Fischer Panda generators feature an effective water-cooling system and a lightweight compact construction. This ensures Fischer Panda is one of the leaders for mobile super-silent diesel generators. These highly-proven marine and vehicle generators supply power to electrical systems, electric drives and complete mobile energy systems.

Worldwide distributors and partners

Our worldwide distributors and partners are able to help you to choose the best generator for your requirements.



Company Headquarters in Paderborn, Germany



Fischer Panda super-silent sound insulation system

Compact and lightweight design

- Quiet operation
- Less space required for installation
- Can be installed anywhere on-board
- Generator can be fitted in centre of gravity
- Hermetically sealed capsule
- All connections pre-fitted on capsule

Panda marine generators up to 25 kW are delivered with a GRP sound insulation capsule with "3D" sound insulation material as standard.

For generators from 25 kW and above, the capsule is delivered as a stainless steel version "Metal-Professional Line" (MPL). The MPL sound insulation casing consists of 6-11 parts (depending on the size of the generator) which makes it easier to dismantle and access all areas within. The MPL capsules are also available at an extra cost for generators from 6 kW to 25 kW.

The sound insulation material is available in three different versions depending on application requirements:

- "3D" - up to 25 mm thick
- "4DS" - up to 40 mm thick
- "6DS" - up to 60 mm thick (only MPL)



GRP Sound insulation capsule is standard for generators up to 25 kW.



Stainless-steel sound-insulation capsule "MPL" for generators from 25 kW.

Dual cooling system of Fischer Panda generators

Fischer Panda has manufactured more than twenty-five thousand marine generators since 1988 with this technology. One of the reasons for the superior efficiency of Panda generators is the very effective cooling system, it ensures that the temperatures inside the sound insulation capsule remain within an acceptable range even in tropical conditions at the same time achieving the best possible sound insulation as free-flowing cooling air is not required.

- Water-cooled windings
- Dual-circuit cooling
- No appreciable warming of engine room

Seawater with high salt content and tropical temperatures increase the danger that metal can be affected by galvanic corrosion (Electrolysis). Even a very small current can have a destructive effect. To prevent this, Fischer Panda uses dual-circuit cooling for generator and engine on all Panda generators from 3.2 kW upwards. The engine and generator are cooled by freshwater. Seawater only comes into contact with the heat exchanger, which is manufactured from a high quality alloy (CuNi10Fe).

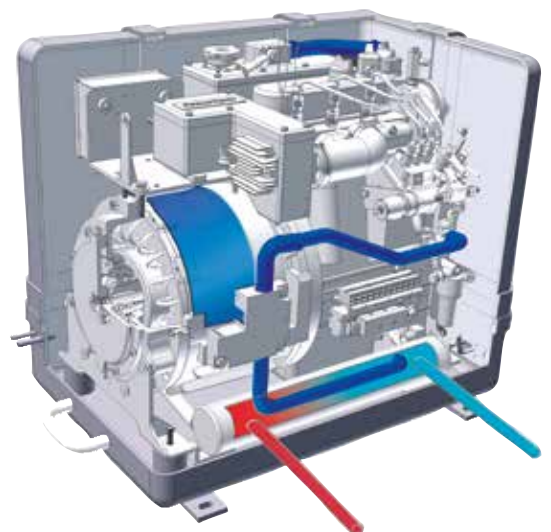



High performance AC windings from Fischer Panda

Single-phase windings

The 230 V 50 Hz, (120/240 V 60 Hz) single phase windings are standard for generators up to 25 kW. A three-phase version should be considered above 12 kW, as the Panda generator permits asymmetrical loads up to 50 % per phase. A Hybrid Power System should also be taken into consideration for small to middle range on-board power systems.

Three-phase windings

The 400 V AC 50 Hz, (208 V 60 Hz) three-phase winding has the highest level of efficiency and the best qualities. This winding can also supply single-phase AC with the appropriate phase distribution. A three-phase generator should always be chosen above 25 kW (from Panda 30).

Reliable and durable

The asynchronous generator delivers high standards regarding both operational security and life. The asynchronous generator is often the preferred choice when a high degree of safety and reliability is demanded.

Fischer Panda warrants the rotor, often the most sensitive part of other generator systems, with a lifetime guarantee. Furthermore, the asynchronous generator continues to be the best suited for water-cooling as the copper winding is the only component producing heat via the stator. The electrical generator is warranted with a 5-year guarantee against corrosion.

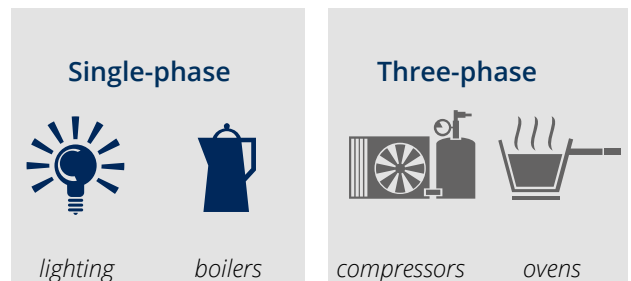

All the benefits of the asynchronous generator:

- Overload protection
- Water-cooled
- Short-circuit stability

- Highest operating protection
- High protection rating
- Brushless

- Perfect sine wave
- No rotating coils
- No diodes

- Precise control
- No signal noise
- Highly efficient

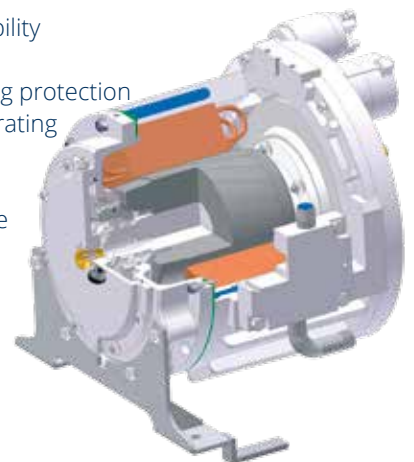

“Perfect Power” iSeries generators

The Panda iSeries generators have been especially designed to be compact, quiet and powerful with up to 30 % weight and space savings! They are ideal for superyacht owners looking for a night generator with low operating sound levels and vibrations. The generators are characterised by their modern, innovative and environmentally friendly inverter technology. iSeries generators using parallel inverters can be connected in parallel without any additional cables and synchronised.

The speed of the diesel engine is adjusted according to the user's changing power requirements while the output voltage always remains constant from the inverter. Variable speed control considerably reduces exhaust emissions and fuel consumption in comparison with a traditional generator with a fixed speed. The maximum speed of the engine is 2800 RPM. The electric load is provided with a constant output voltage of 230 V / 50 Hz or 400 V / 50 Hz via an inverter.



Perfect Power

- Highly efficient - maximum energy
- Variable speed - load-dependent
- Meets latest emission standards
- Modular design ensures installation flexibility
- Extremely stable voltage and frequency
- Optional CAN SAE J1939 Interface

“Compact Power” generators

Basic Line: Fischer Panda generators without electronic regulation

These Panda generators are ideal for those interested in a favourable price. Basic Line generators are not fitted with electronic speed control. Other major parts: motor, generator, sound insulation casing, and water-cooling are identical to Premium Line models. The voltage tolerance lies within an acceptable range of $\pm 8\%$ (similar to a shore power connection).



Compact Power

Premium Line: Fischer Panda generators with xControl

The “xControl” management system offers a easy to operate system, a modern and simple system architecture and a modern communication interface. It replaces the current VCS control on Fischer Panda asynchronous generators. Modern data communications and energy systems require that the generator is able to integrate with an existing control and regulation system. With the “xControl”, Fischer Panda offers an extremely powerful and user-friendly generator control system. Through intelligent communication of three main system components (digital panel, connection box and control unit), a reliable operation of the generator is ensured.



“Hybrid Power” generators (AC indirect)

AGT-DC Line: Fischer Panda battery charging generators

Fischer Panda battery charging generators produce direct current and generally function as part of a Hybrid Power System. Battery levels are monitored and automatically charged by the generator. An inverter supplies energy to the 230V consumers on-board. These systems are ideal for typically varying power demands which do not require a generator to constantly run throughout the day.



Hybrid Power



Fischer Panda generators - easy to use and operate

Fischer Panda panels allow the generator to be operated from another location onboard. Important operating information is displayed. Options are available for connecting panels in parallel or with a slave panel. The generator can then be operated from multiple locations for even more flexibility. A panel can be installed in the cabin and another panel can be installed on the flybridge or in the engine room.



Panel P4 Control for Panda 4000s.Neo PMS Generator



iControl Panel for "Perfect Power" iSeries Generators



xControl Panel for "Compact Power" xSeries Generators

The standard version remote control panel (for models over 30 kW)

monitors the following functions:

- Engine coolant temperature
- Engine exhaust temperature
- Engine oil pressure
- Battery charging
- 230 Volt AC
- Cooling-water leakage (optional)



Standard Panel for „Compact Power“ Generators over 30 kW

The generator switches itself off when any of these functions are not in the normal state. An automatic module to start (and stop) the generator via external devices such as timers is optionally available.



"AGT Panel" for "Hybrid Power" DC Generators

Innovative generator control

Innovative, flexible and reliable – these are the attributes of the new generator control from Fischer Panda for **“Perfect Power” iSeries generators** and **“Compact Power” xSeries generators** up to 30 kW.

In the age of modern data communications and energy systems, it is more and more important that the generator is able to integrate with an existing control and regulation system. Fischer Panda offers an extremely powerful and user-friendly generator control system:

- “Plug & Play” - reduced installation effort
- Modular system - easy to expand
- Logging and display of operational data - complete control at all times
- Comprehensive event logging - long term service
- Digital panel - easy to use and multilingual
- Communications interface - integration in other control systems
- Self-test of all functions - safe and reliable system
- Automatic start - remote control of generator
- Fast control - stable energy supply

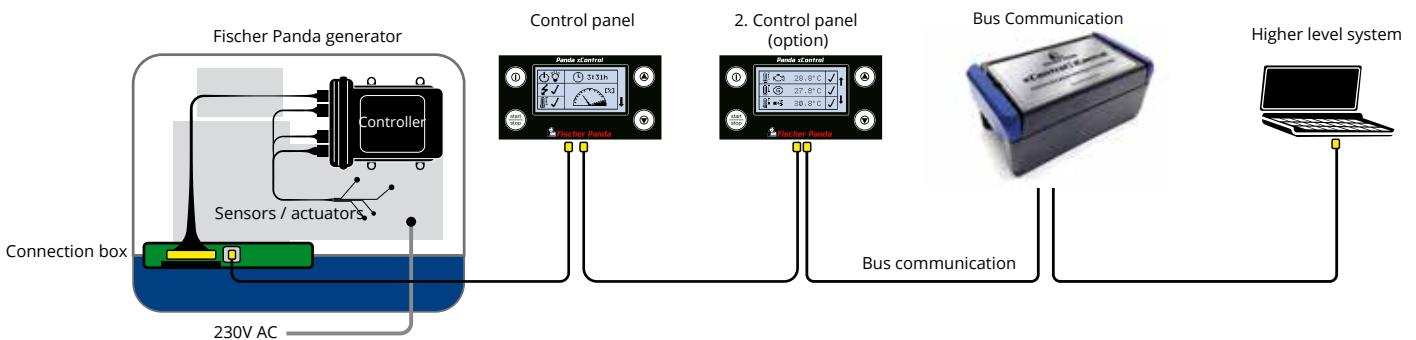

Perfect sine wave

The Panda combines all the advantages of the asynchronous generator with the voltage control of a synchronous generator.

Asynchronous Panda generators supply a particularly clean sine wave and have achieved the best results during numerous tests in this category. This is essential for the smooth running of sensitive electronic devices such as air conditioners, charging devices, laser printers etc.

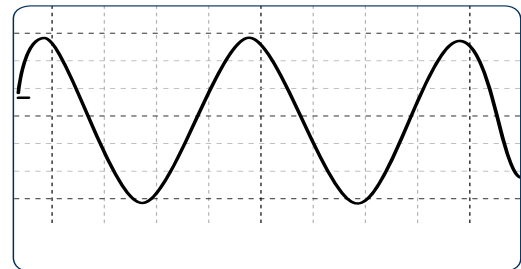

The outstanding sine wave of the Fischer Panda generator

Voltage stability with Voltage Control System (VCS) tolerance $\pm 3V$

Fischer Panda generators have used their own electronic Voltage Control System (VCS) for controlling generator and engine. The engine speed is progressively controlled. This ensures that the output voltage of the asynchronous generator has a tolerance of $\pm 3V$.

SAEJ1939 CANBus Module for xControl / iControl

The Fischer Panda FP Bus provides 100 % SAEJ1939 functionality. This allows the generator to be integrated into a higher level control system. The generator can be remotely started and stopped. All electrical data can be accessed via the bus: voltage, current, frequency and power. Monitoring information such as cooling, exhaust and oil temperatures etc. can also be accessed.



SAEJ1939 CANBus Module for xControl / iControl

Fischer Panda "Perfect Power" iSeries generators with variable speed

Generators with variable speed for reduced fuel consumption, quiet operation and less exhaust emissions.

Up to 50 % less weight and 30 % space savings when compared to asynchronous generators of the same class

Panda iSeries marine inverter generators with variable speed technology

- 50 Hz - 230V
- 50 Hz - 400V
- 60 Hz - 120V
- 60 Hz - 230 V
- 60 Hz - 2 x 120 V / 240 V

variable speed - load dependent



Model			Panda 5000i.Neo PMS	Panda 5000i PMS	Panda 8000i PMS	Panda 10000i PMS
Nominal performance*)	230V 1-phase 50 Hz (also 1-phase 60 Hz)	kW	0-4,0*	0-4,0*	0-6,4*	0-8,0*
		kVA	0-5,0*	0-5,0*	0-8,0*	0-10,0*
	400V 3-phase 50 Hz	kW				
		kVA				
	230V 1-phase 60 Hz	kW			0-6,0*	0-8,0*
		kVA			0-7,5*	0-10,0*
	120 V 1-phase 60 Hz (request : 2 x 120 V / 240 V)	kW	0-4,0*	0-4,0	0-6,0	0-8,0
		kVA	0-5,0*	0-5,0	0-7,5	0-10,0
Engine speed	rpm	2500-3250	2400-2800	2400-2800	2400-2800	
Voltage tolerance	%	± 3 %	± 3 %	± 3 %	± 3 %	
Frequency		50 Hz ± 0,1 Hz	50 Hz ± 0,1 Hz	50 Hz ± 0,1 Hz	50 Hz ± 0,1 Hz	
Control		iControl	iControl	iControl	iControl	
Cooling circuits		2	2	2	2	
Capsule type		GFK	GFK	GFK	GFK	
Sound insulation		3D	3D	3D	3D	
Engine manufacturer		Fischer Panda	Kubota	Kubota	Kubota	
Engine type		FPE320	EA 300	Z482	Z602	
Engine displacement	cm ³	309	309	479	599	
Number of cylinders		1	1	2	2	
Sound level 7m / 3m / 1m	dbA	54 / 64 / 68	54 / 64 / 68	52 / 62 / 67	52 / 62 / 67	
Approx. capsule dimensions excl. fittings L x W x H	mm	434 456 519	600 399 406	520 445 545	540 445 555	
Approx. weight incl. capsule	kg	67 + Inverter 9,7	82 + Inverter 9,7	105 + Inverter 9,7	111 + Inverter 13,5	

The data in this publication reflects the technical state at time of print. Due to our policy of continual product development, we reserve the right to alter technical specifications without notice. Dimensions apply for the sound insulation capsule only and do not include latches, fittings etc. Additional room will need to be calculated for the installation to include hoses, cables and capsule mountings. Please confirm current dimensions and weights when ordering. Dimensions and weights are approximate values only.

Fuel savings
up to 20 %
 50 ct per operating hour
 (at 1€ per liter diesel)

Perfect Power



Panda 15000i-230V PMS	Panda 15000i-400V PMS	Panda 19i PMS	Panda 25i-230V PMS	Panda 25i-400V PMS	Panda 45i PMS	Panda 60i PMS
0-12,0**			0 -20,0***		0-36,0 ***	
0-15,0**			0-25,0***		0-45,0 ***	
	0-12,0*			0 -20,0 ***	0-36,0 ***	0-48,0 ***
	0-15,0*			0-25,0 ***	0-45,0 ***	0-60,0 ***
0-12,0**		0-15,0***	0 -20,0***			
0-15,0**		0-18,7***	0-25,0***			
0-12,0**	0-12,0*	0-15,0***				
0-15,0**	0-15,0*	0-18,7***				
2200-2800	2200-2800	2200-3600	2200-2800	1500-2800	1500-2700	1500-2800
± 3 %	± 3 %	± 3 %	± 3 %	± 3 %	±3 %	±3 %
50 Hz ± 0,1 Hz	50 Hz ± 0,1 Hz	50 Hz ± 0,1 Hz	50 Hz ± 0,1 Hz	50 Hz ± 0,1 Hz	50 Hz ± 0,1 Hz	50 Hz ± 0,1 Hz
iControl	iControl	iControl	iControl	iControl	iControl	iControl
2	2	2	4	4	2	2
GFK	GFK	GFK	GFK	GFK	MPL	MPL
3D	3D	3D	4DS	4DS	4DS	6DS
Kubota	Kubota	Kubota	Kubota	Kubota	Kubota	Hatz
D902	D902	D902	V1505	V1505	V2403T	4H50TIC
898	898	898	1498	1498	2434	1952
3	3	3	4	4	4	4
54 / 64 / 68	54 / 64 / 68	54 / 64 / 68	55 / 60 / 70	55 / 60 / 70	54 / 59 / 69	55 / 60 / 70
650	650	650	840	840	1130	1313
465	465	465	520	520	660	800
589	589	582	664	664	810	870
160 + Inverter 16	160 + Inverter 21	162 + Inverter 21	230 + Inverter 19	230 + Inverter 39	545	670

NOTE: For inverter generators - performance is calculated with :

*) cosPhi factor = 0,8 up to 40°C ambient temperature, otherwise calculate with a factor 1 up to 50°C.

***) cosPhi factor = 0,8 up to 40°C ambient temperature, otherwise calculate with a factor 1 up to 50°C (air-cooling. Other temperatures available on request)

*) cosPhi factor = 0,8 up to 50°C ambient temperature, otherwise calculate with a factor 1 up to 50°C (water-cooling)

***) cosPhi factor = 0,8 up to 50°C ambient temperature, otherwise calculate with a factor 1 up to 50°C (water-cooling)

Fischer Panda "Compact Power" generators

Suitable for applications requiring continuous power and high starting capabilities with a very stable voltage supply

Marine generators from Panda 7 Mini with voltage regulation and voltage tolerance $\pm 3V$

- 3000 rpm - 50 Hz - 230V
- 3000 rpm - 50 Hz - 400V
- 3600 rpm - 60 Hz - 120 / 240V
- 3600 rpm - 60 Hz - 208V AC



Model			Panda 4000s.Neo PMS	Panda 4K PMS	Panda 7 Mini PMS	Panda 8000x PMS	Panda 8 Mini PMS	Panda 10000x PMS
Nominal performance*)	230V 1-phase 50 Hz	kW	3.4			6.8		8.0
		kVA	4.0			8.0		9.4
	400V 3-phase 50 Hz	kW				6.8		8.0
		kVA				8.0		9.4
	120 V on request 1-phase 60 Hz (request : 2 x 120 V / 240 V)	kW		4,0	6.0		7.5	
		kVA		4,7	6.0		7.5	
Engine speed	rpm	3000	3600	3600	3000	3600	3000	
Voltage tolerance		$\pm 5 \%$	$\pm 5 \%$	$\pm 3 V$	$\pm 3 V$	$\pm 3 V$	$\pm 3 V$	
Control		-	-	VCS	xControl	VCS	xControl	
Cooling circuits		2	2	2	2	2	2	
Capsule type		GFK	GFK	GFK	GFK	GFK	GFK	
Sound insulation		3D	3D	3D	3D	3D	3D	
Engine manufacturer		Fischer Panda	Kubota	Kubota	Kubota	Kubota	Kubota	
Engine type		FPE320	Z482	Z482	Z482	Z482	Z602	
Engine displacement		298	479	479	479	479	599	
Number of cylinders		1	2	2	2	2	2	
Sound level 7m / 3m / 1m	dba	54 / 64 / 69	52 / 62 / 67	52 / 62 / 67	52 / 62 / 67	53 / 63 / 68	52 / 62 / 67	
Approx. capsule dimensions excl. fittings L x W x H	mm	550 450 518	540 445 554	595 445 555	595 445 555	595 445 555	650 445 570	
Approx. weight incl. capsule	kg	93	132	163	164	163	175	

The data in this publication reflects the technical state at time of print. Due to our policy of continual product development, we reserve the right to alter technical specifications without notice. Dimensions apply for the sound insulation capsule only and do not include latches, fittings etc. Additional room will need to be calculated for the installation to include hoses, cables and capsule mountings. Please confirm current dimensions and weights when ordering.

*Compact
Power*



Panda 12000x PMS	Panda 12 Mini PMS	Panda 15000x PMS	Panda 18x PMS	Panda 24x PMS	Panda 30x PMS	Panda 30ICx PMS
10.2		12.7	15.3	20.4	25.5	27
12.0		15.0	18.0	24	30	31.7
10.2		12.7	15.3	20.4	25.5	27
12.0		15.0	18.0	24	30	31.7
	11.5					
	11.5					
3000	3600	3000	3000	3000	3000	3000
±3 V	±3 V	±3 V	±3 V	±3 V	±3 V	±3 V
xControl	VCS	xControl	xControl	xControl	xControl	xControl
2	2	2	2	2	2	2
GFK	GFK	GFK	GFK	GFK	GFK	GFK
3D	3D	3D	3D	3D	3D	3D
Kubota	Kubota	Kubota	Kubota	Kubota	Kubota	Kubota
D722	D722	D902	D1105	V1505	V1505T	V1505T IC
719	719	898	1123	1498	1498	1498
3	3	3	3	4	4	4
53 / 63 / 67	54 / 64 / 68	54 / 64 / 68	55 / 65 / 69	55 / 65 / 69	55 / 65 / 69	55 / 65 / 69
705	705	740	832	1010	1010	1010
450	450	480	517	515	515	515
590	587	600	620	674	674	674
195	195	248	297	355	403	403

NOTE: *) For asynchronous generators up to and including P15000: the KVA is calculated with $\cos\Phi = 0.85$ for a short starting performance of inductive consumers. Otherwise it should be calculated with a factor of 1. Generators above and including Panda 16 with an optional start performance with compensation or starting-current booster are calculated with $\cos\Phi = 0.85$ otherwise it should be calculated with a factor of 1.

Fischer Panda "Hybrid Power" DC generators

Hybrid
Power

The ideal battery-charging generators for battery systems which may be required to power larger consumers for short periods during the day.

Panda AGT-DC marine generators

- **12 V / 24 V / 48 V**
- (other voltages available on request)

Model		AGT-DC 4000-12V PMS	AGT-DC 4000-24V PMS	AGT-DC 5000-12V PMS	AGT-DC 6000-24V PMS	AGT-DC 8000-24V PMS	AGT-DC 10000-48V PMS
Continuous performance ¹⁾	kW	3.2	3.2	4.0	4.8	6.4	9.1
Nominal voltage	V	12	24	12	24	24	
Constant current rate	A	220	110	277	170	220	
Engine speed	rpm	2400-3000	2400-3000	1800-2200	2400-3200	2200-2600	2300-2900
Control		VCS	VCS	VCS	VCS	VCS	VCS
Cooling circuits		2	2	2	2	2	2
Sound insulation		GFK	GFK	GFK	GFK	GFK	GFK
Capsule type		3D	3D	3D	3D	3D	3D
Engine manufacturer		Kubota	Kubota	Kubota	Kubota	Kubota	Kubota
Engine type		EA300	EA300	Z482	Z482	D722	D722
Engine displacement	cm ³	309	309	479	479	719	719
Cylinders		1	1	2	2	3	3
Sound level 7 m / 3 m / 1 m	dB(A)	54/64/68	54/64/68	53/63/68	53/63/68	53 / 63 / 68	53 / 63 / 67
Approx. capsule dimensions excl. fittings L x W x H	mm	598 398 410	598 398 410	560 510 584	560 510 584	660 515 594	660 515 594
Approx. weight incl. capsule	kg	90	90	139	139	160	160

The data in this publication reflects the technical state at time of print. Due to our policy of continual product development, we reserve the right to alter technical specifications without notice.

Dimensions apply for the sound insulation capsule only and do not include latches, fittings etc. Additional room will need to be calculated for the installation to include hoses, cables and capsule mountings.

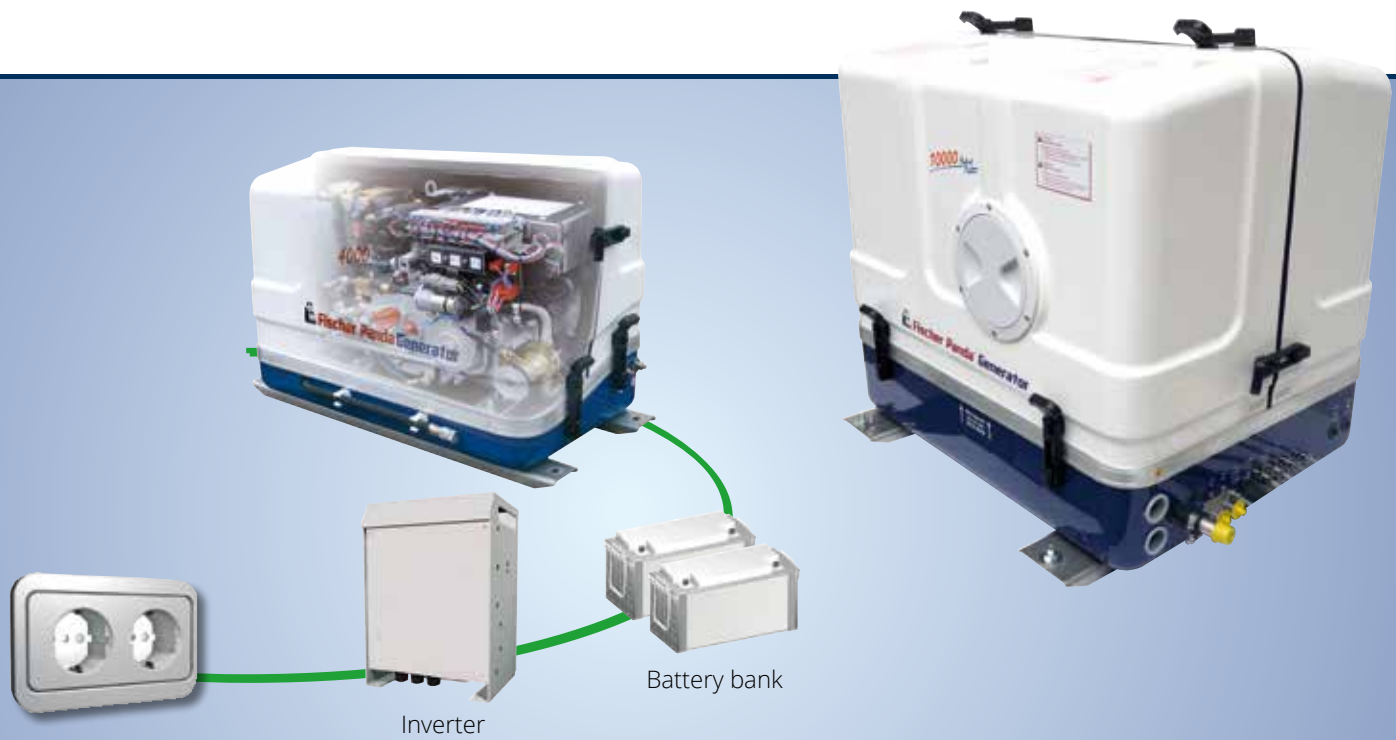

AGT-DC 11000 48V PMS	AGT-DC 13000 48V PMS	AGT-DC 15000 PMS	AGT-DC 18000 PMS	AGT-DC 22000 PMS	AGT-DC 25000 PMS	AGT-DC PMS
10.9	12.7	15.6	17.9	21.9	24	
12 V - 400 V versions available. Current dependent upon voltage						
2300-2900	2400-3000	2400-3000	2400-3000	2400-3000	2400-3000	
VCS	VCS	VCS	VCS	VCS	VCS	
2	2	2	2	2	2	
GFK	GFK	GFK	GFK	MPL	MPL	
3D	3D	3D	3D	4DS	4DS	>= 25kW * Versions available on request.
Kubota	Kubota	Kubota	Kubota	Kubota	Kubota	
D902	D1105	D1305	V1505	V1505T	V2403	
898	1123	1261	1498	1498	2434	
3	3	3	4	4	4	
54 / 64 / 68	55 / 65 / 69	55 / 65 / 69	55 / 65 / 69	55 / 65 / 69	54 / 64 / 68	
660 580 616	760 515 613	825 510 658	870 540 675	980 600 700	1200 720 920	
170	226	250	265	350	request	

¹⁾The performance of an AGT-DC generator must be limited to the constant performance when batteries are used.

Parallel power from Fischer Panda generators



Load transfer for Fischer Panda generators with xControl

“Plug and play” load switching using xControl

The xControl PD-A (Parallel Device) module allows two Fischer Panda xControl AC generators to be connected in parallel. Electrical loads can be switched from one generator to another (uninterrupted) or their outputs can be combined (load sharing).

The PD-A is connected to each generator’s data bus. The generators are set to “parallel-mode” via the xControl display menu. The PD-A monitors both generators and synchronises their output. The load is switched from one generator to the other when their outputs are synchronised. Both single and three phase generators can be connected in parallel using the PD-A module.

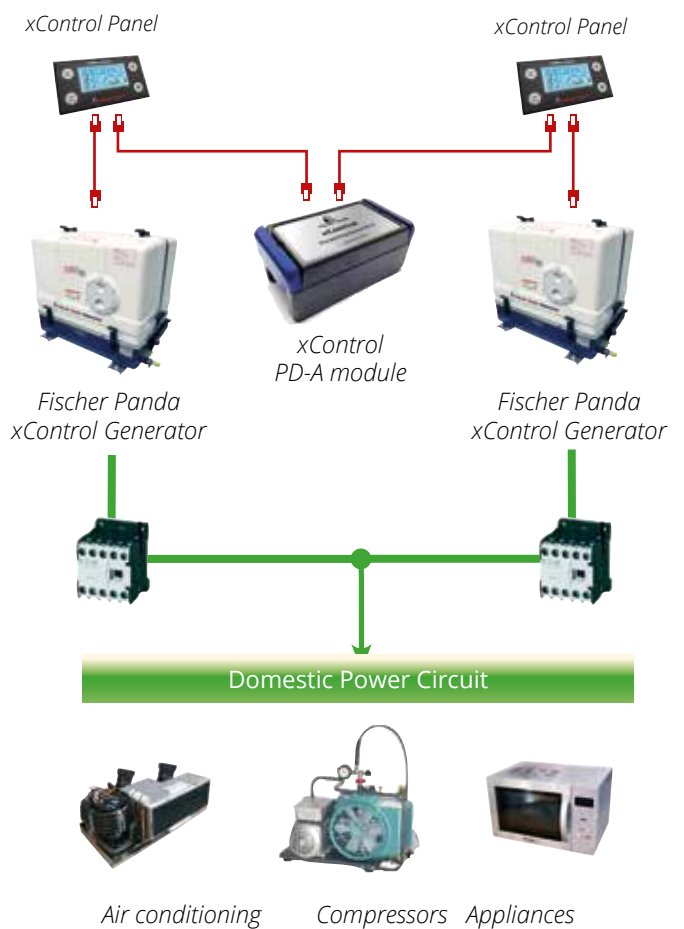

All generators with xControl can operate in parallel



Perfect for multihulls

Fischer Panda Parallel "iSeries" generators

High performance solution for even more comfort and safety

Optional available parallel inverters can be used to easily connect several iSeries generators of different types in parallel. Extra cables or additional cabinets are not required. Each generator is fully independent and can be individually operated.

- Multiple generators can be easily connected in parallel - even if they have different outputs using "parallel" inverters (optional).
- Load-Sharing: both generators are equally loaded when operating in parallel.
- Ideal for applications such as multihulls which may benefit from installing various smaller generators to improve weight distribution.

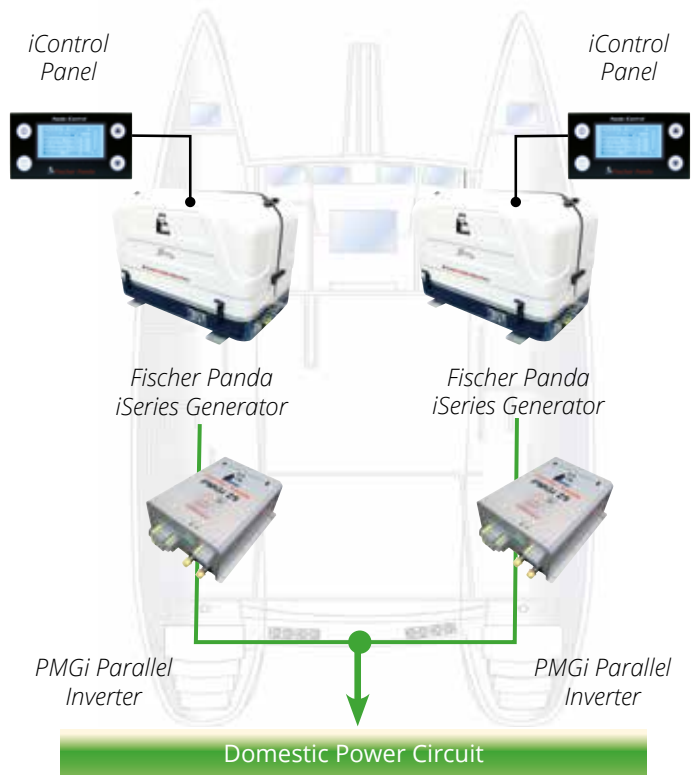

PMGi Parallel Inverter



Air conditioning Compressors Appliances

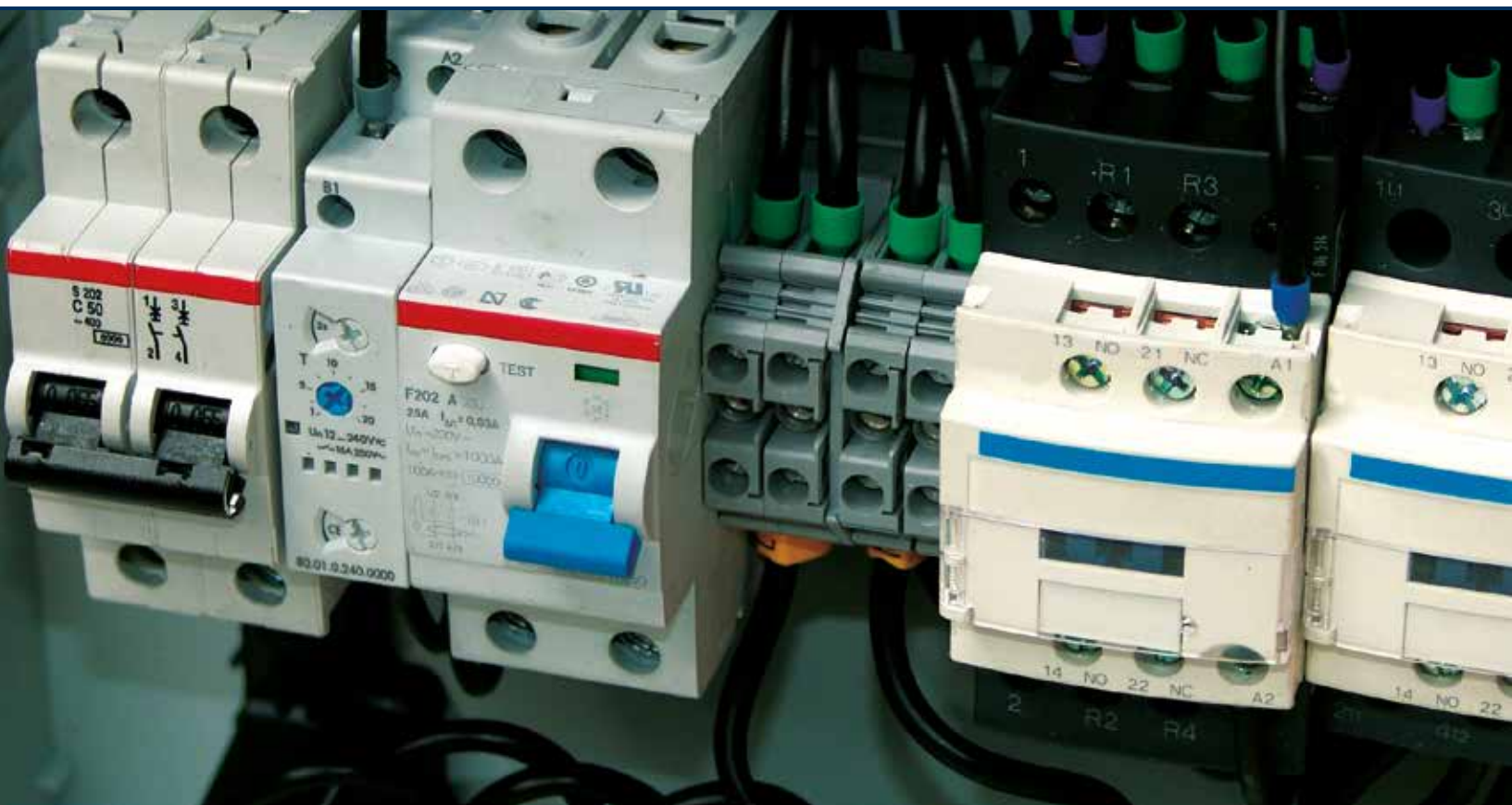

Automatic transfer from shore power to Fischer Panda generator

Automatic transfer if shore power fails

The Fischer Panda Automatic Transfer Unit monitors the presence of AC shore power. If the shore power supply is not available, the AC Generator is automatically started. As soon as the shore power supply has been restored, the power can be manually switched back (if required) and the AC generator can be stopped.

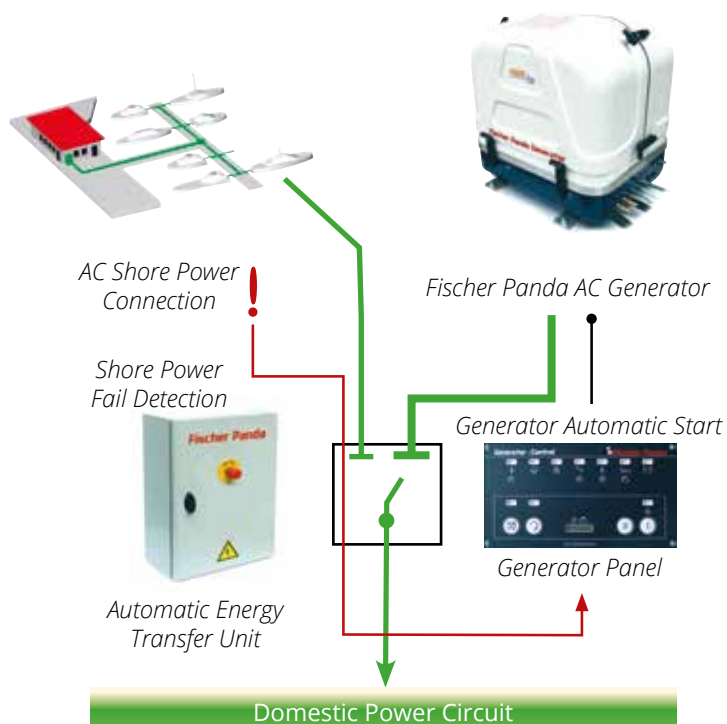

Umschalteinheit



Air Conditioning



Domestic Electrical Appliances



Fridges / Freezers



Fischer Panda also offers an extended Generator-Guarantee for North America and South America
Further information:
www.fischerpanda.de

Fischer Panda Warranty Plus

More security and peace of mind with your Fischer Panda generator

What is the extended Fischer Panda Guarantee?

The extended Fischer Panda Guarantee^{**}) is a component of the generator warranty. Once accepted, it applies up to the first inspection/interval service and extends thereafter automatically up to the respective next inspection/interval service at a Fischer Panda Service Partner but not beyond the specified date on the certificate of guarantee.*

Fischer Panda generators are issued with a Basic Guarantee.

The Basic Guarantee^{**}) is free of charge for you and applies generally from the date of delivery by Fischer Panda provided that regular and proven maintenance with original Fischer Panda parts has been carried out.*

Commercial usage 1 year or 1000 operation hours ¹⁾

Private usage 2 years or 1000 operation hours ¹⁾

The Basic Guarantee^{**}) also provides for an additional 5 years from the delivery date for electrical parts of asynchronous generators (stator with winding, alternator housing, sealing and all water-bearing parts). This extended warranty covers damage caused by cooling water to the above mentioned parts. An additional 10 years' guarantee on the rotor from the date of delivery is also included.*

*) Please consult the Fischer Panda Warranty Plus for the exact requirements and conditions for Extended Warranty, Guarantee and Warranty packs. Furthermore, the general Guarantee Conditions for mobile and stationary Fischer Panda generators apply.

***) The above listed guarantee / warranty packages are only available for Fischer Panda marine und commercial vehicle generators.

1) Whichever comes first.

Warranty Pack 1000^{**})

If your Fischer Panda generator has been installed and commissioned by an official Fischer Panda Partner and the installation is confirmed by sending the commissioning protocol to Fischer Panda GmbH Germany, a 1000 Plus Warranty can be applied for. This is free of charge and extends the Basic Guarantee by 3 years or max. 1000 operation hours. ¹⁾*

Warranty Packs 1250 and 1500^{**})

These additional warranty packs can be arranged with the purchase of the generator to provide cover for generators which will be used for longer operational periods.*

Options for buyers of Fischer Panda generators whereby the previous owners did not follow the specified service intervals.

Under certain circumstances, a "1250 Refit" warranty may be considered and granted for owners of a used Fischer Panda Generator.





Installation and custom services by Fischer Panda

Installation kits

Fischer Panda supplies installation kits with all the necessary cables, hoses, connection pieces and accessories to ensure that the system can be correctly installed in a yacht's engine room, catamaran's hull or inside a vehicle. This even includes specific hose and cable lengths.



Custom services for special requirements

Fischer Panda offers a wide range of services for customising and adapting generators for use with special equipments and commercial applications. This includes electric-magnetic hydraulic couplings to drive mechanical hydraulic pumps and mounting slides to access the generator for service purposes.



Powerful energy systems

Fischer Panda marine generators form the backbone of our intelligent and innovative system solutions. These ensure you have sufficient energy even when there is no shore power connection available. It is possible to enhance an existing installation and interface with the yacht's control system.

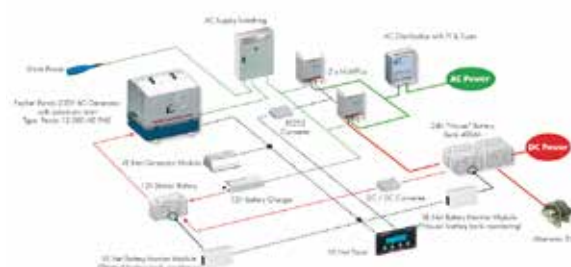



Service and support for Fischer Panda customers

Service kits

Fischer Panda Service Kits include only original spare parts which meet their required specifications. The Fischer Panda service kits are suited for the type of servicing normally carried out by workshops. Fischer Panda Service Plus Kits include only the original spare parts which meet their required specifications and all the relevant spare parts for the first 600 h service intervals. Service Plus kits are supplied in a handy waterproof plastic box so all the items are protected while storing.

The Fischer Panda Installation Guide can be downloaded from the company website at: <http://www.fischerpanda.de/installation>



Global Service Directory

With a coordinated network of distributors, dealers and service stations, Fischer Panda has trained specialists and a worldwide dealer network ready to help, advise and recommend the best service station depending on your location of your vehicle or yacht. They will also be able to organise and coordinate resources and parts so we can provide you with the best service - wherever you are.

The Global Service Directory can be downloaded from the company website at: <http://www.fischerpanda.de/globalservice>



Fischer Panda SOS-24/7 hotline

In case of a generator failure or urgent enquiries of any kind outside our normal business hours you can ring the Fischer Panda switchboard on +49 5254 9202-767 (SOS on a key-operated telephone). Please leave your name, number and the purpose of your call on the answerphone/voice mail. This customer service is operated around the clock by employees at Fischer Panda.





Photo: Nicolas Claris



Fischer Panda GmbH
Otto-Hahn-Str. 40
33104 Paderborn
Germany

Tel. : +49 5254 9202-0
Fax : +49 5254 9202-550
Email : info@fischerpanda.de
Web : www.fischerpanda.de



Compact



Light



Quiet

Disclaimer:

The information contained here is to the best of our knowledge accurate at the date of publication. Please note that the data in this publication reflects the technical state at time of print. Dimensions apply for the sound insulation capsule only and do not include latches or fittings etc. Additional room will need to be calculated for the installation to include hoses, cables and capsule mountings. Additional components or alternators may also affect capsule dimensions. Due to our policy of continual product development, we reserve the right to alter technical specifications without notice. All performance data relates to air and water temperatures of 20 °C. Performance reduction (approx. 1 % per 100 m height and approximately 2 % per 5 °C air temperature and approximately 1 % per 1 °C water temperature above 20 °C)

Stand: 11-2020